

## SOFT - KAMMERLEISTEN

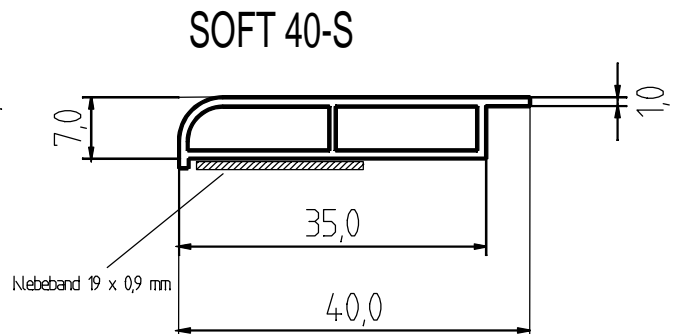

# KAMMERLEISTEN OHNE FAHNE

Wandstärke 1,0 mm

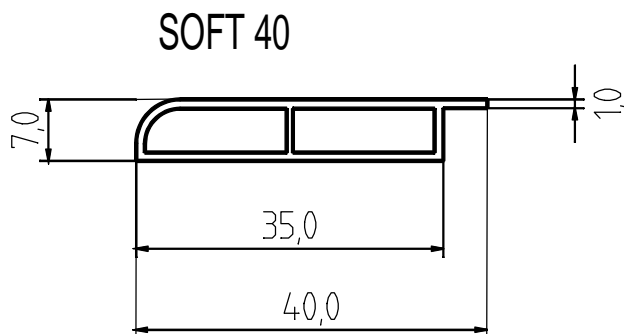
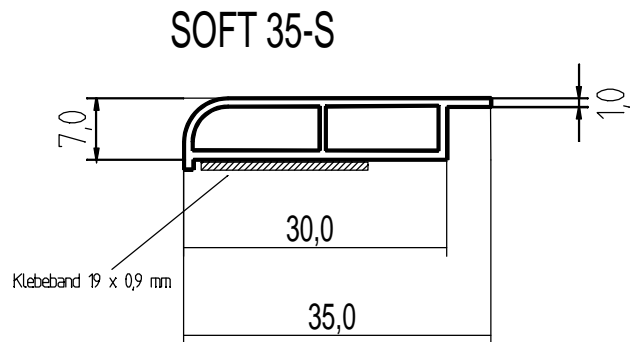
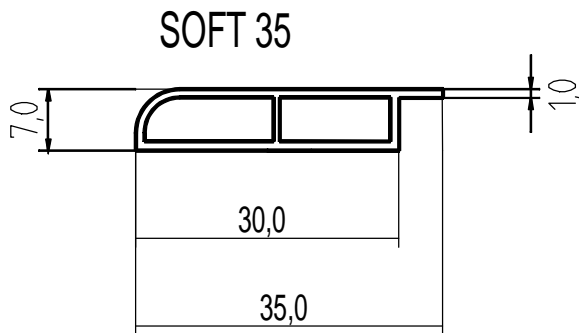
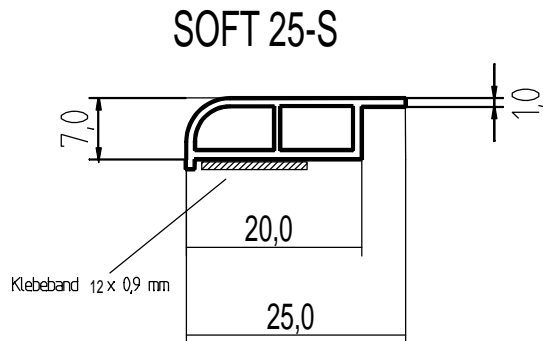
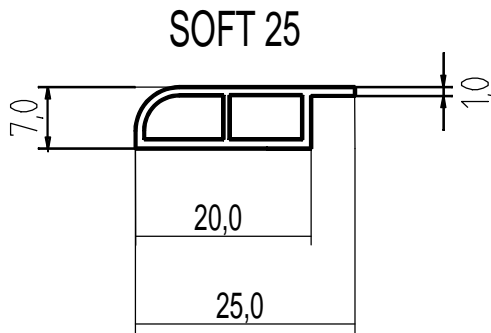
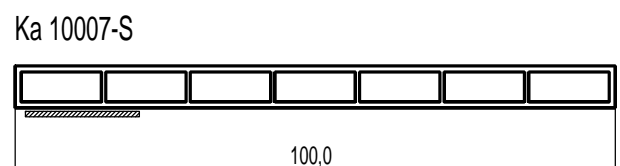
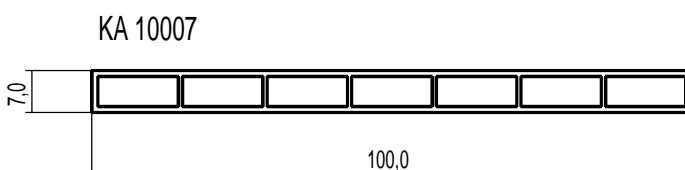
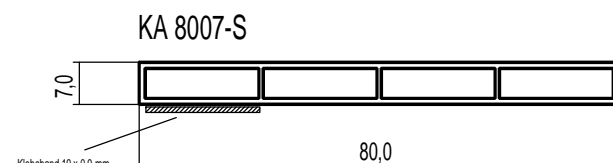
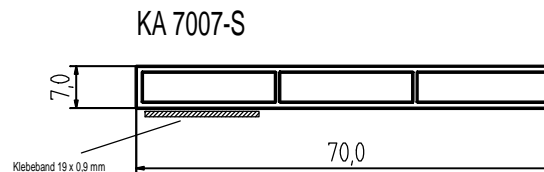
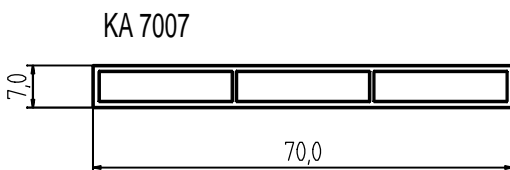
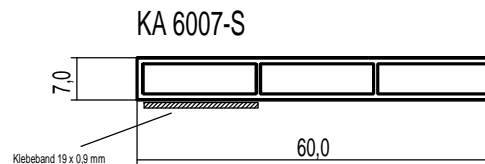
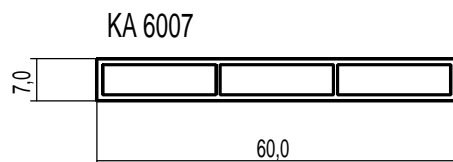
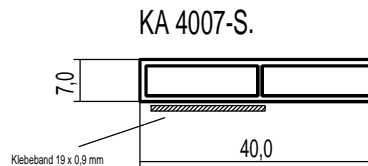
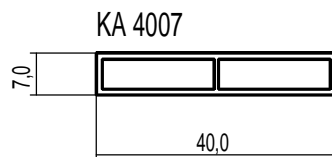
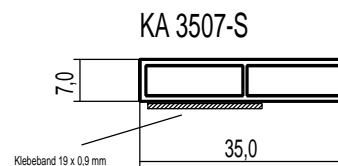
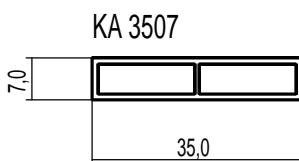
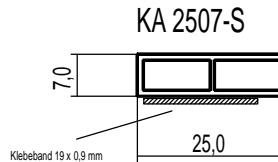
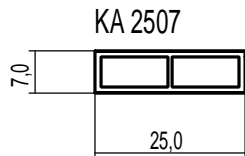
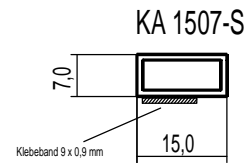
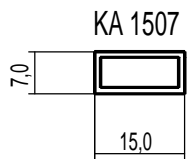

## KAMMERLEISTEN MIT FAHNE

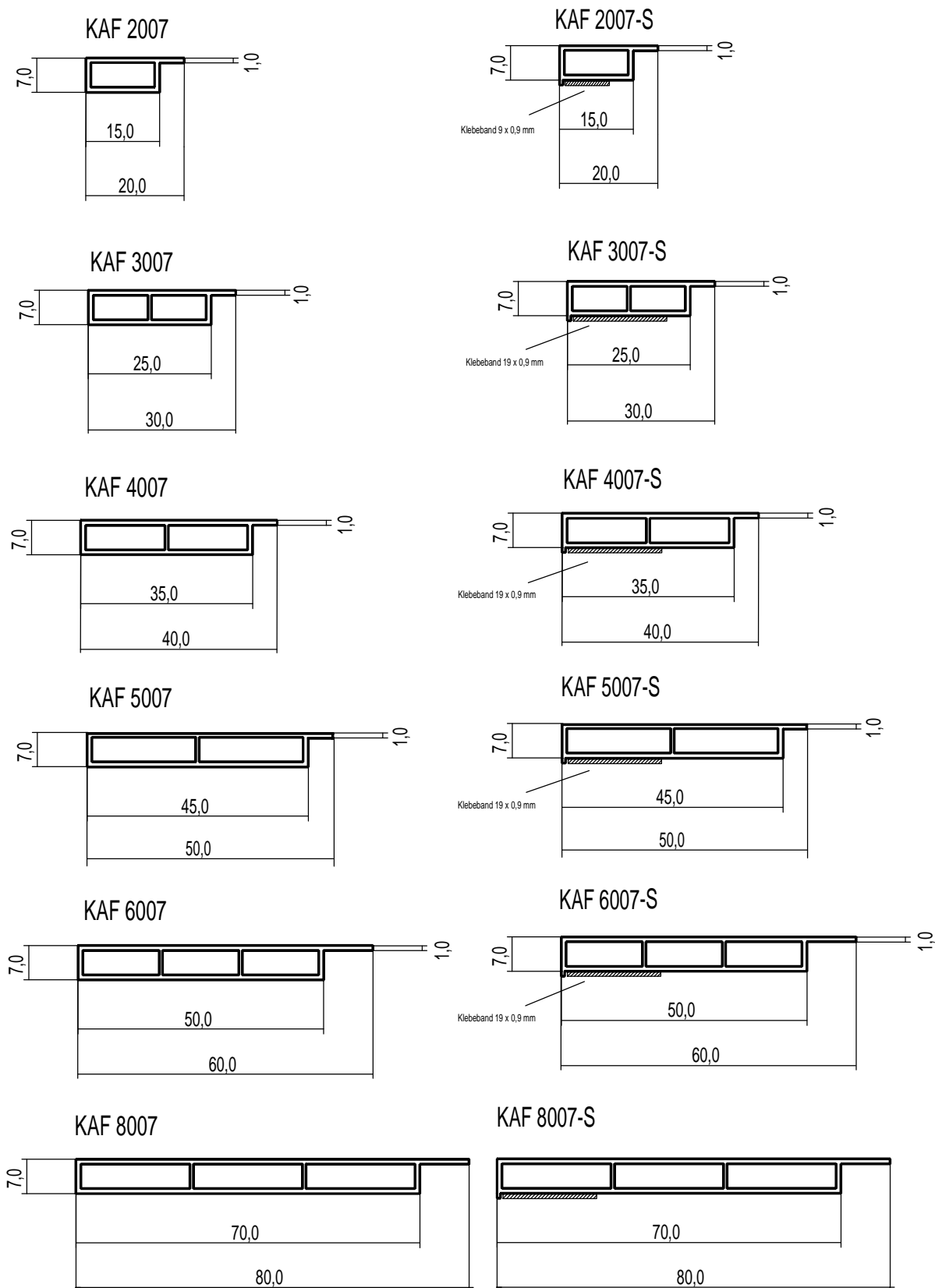

**KAMMERLEISTEN 15 mm stark**

Wandstärke 1,0

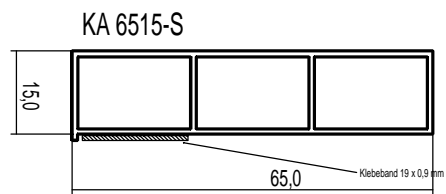
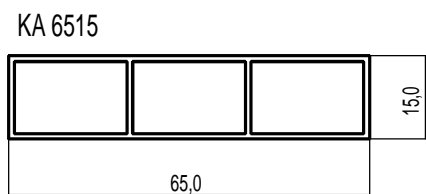
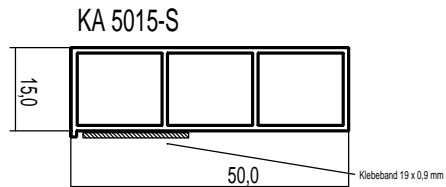
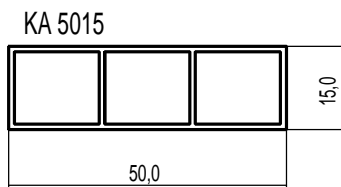
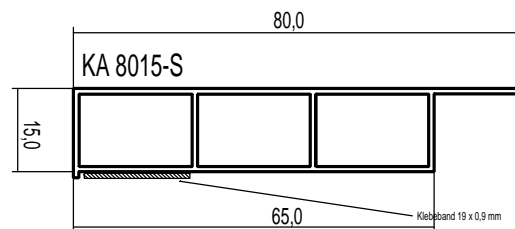
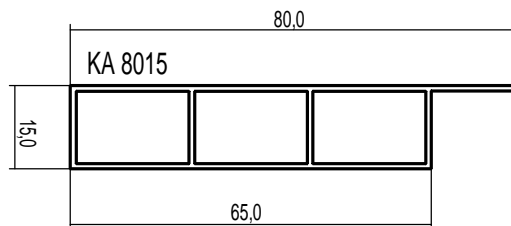
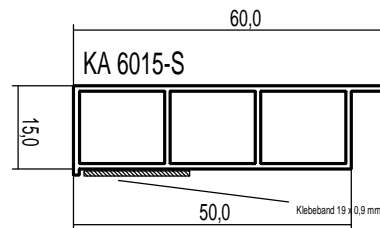
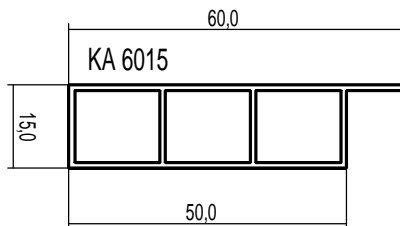
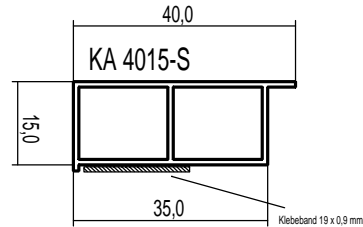
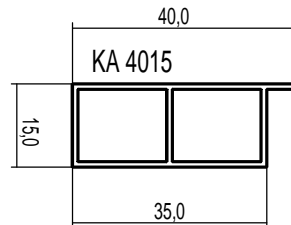
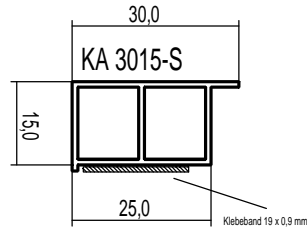
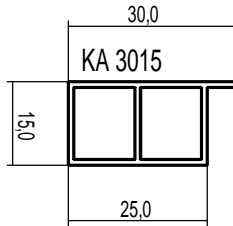
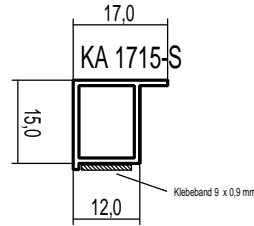
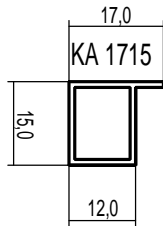

## KAMMERLEISTEN SELBSTKLEBEND MIT PU-WEICHSCHAUM-BAND

KA1715-SPU

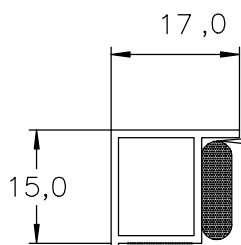

KA3015-SPU

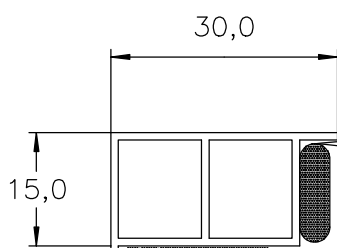

KA4015-SPU

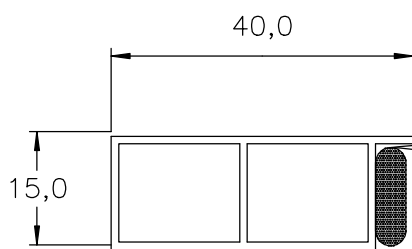

KA6015-SPU

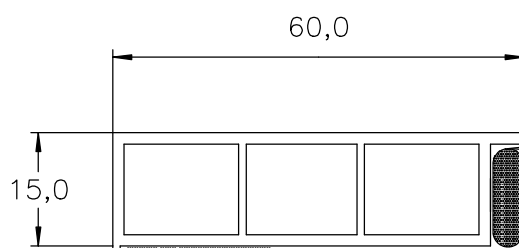

KA8015-SPU

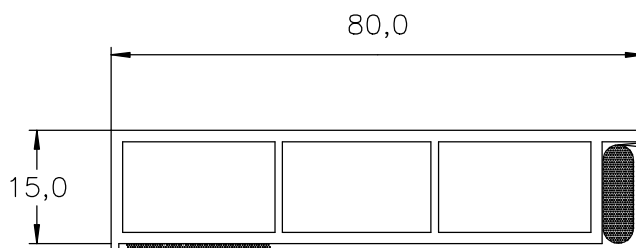

PU-Weichschaumband  
in PP-Folie, komprimiert  
verschlossen.

Der Verschluss bildet  
durch Perforation und  
Reissfaden die Abriss-  
zone für die über-  
stehende Folie.

(Profile dienen zur  
inneren Abdichtung).

# KAMMERLEISTEN 16 mm stark Wandstärke 1,5 mm

KAP 4016/Ri

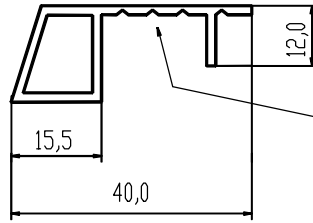

mit Rillen (Abrisskanten)  
 kürzbar auf verschiedene Breiten

KAP 4016

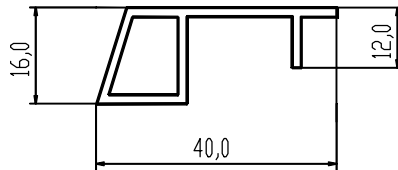

KAP 4016-S

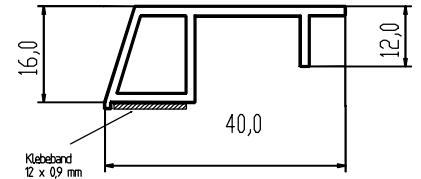

KA 1816

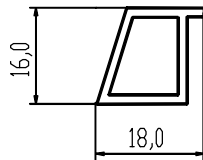

KA 1816-S

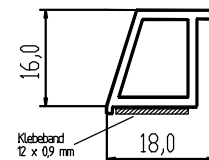

KA 2216

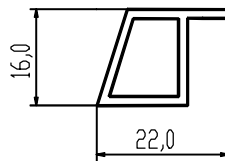

KA 2216-S

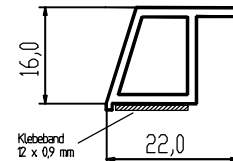

KA 2716

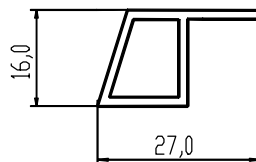

KA 2716-S

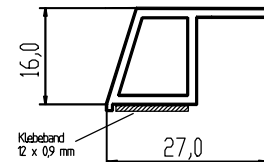

KA 3416

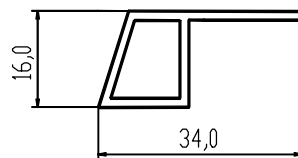

KA 3416-S

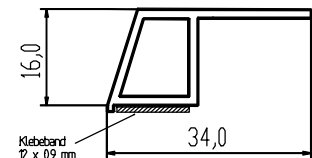

KA 3816

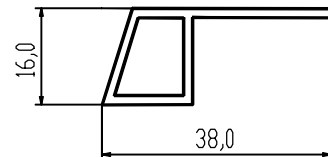

KA 3816-S

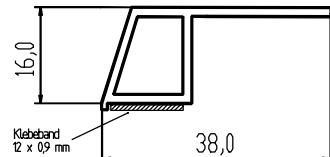

# KAMMERLEISTEN 9, 10 und 11 mm

KA 2409

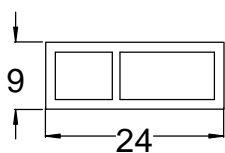

KA 4009

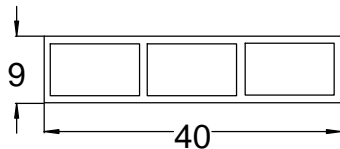

KA 4610

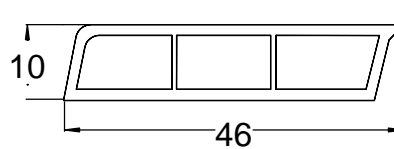

TRV 6010

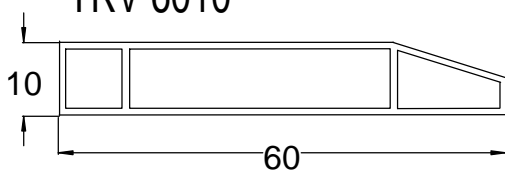

KA 4610-S

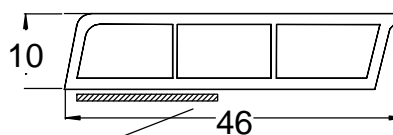

Klebeband 19 x 0,9 mm

KA 6010

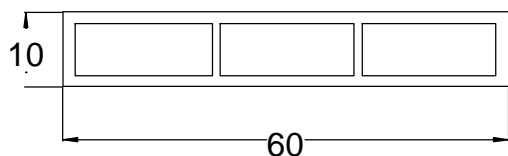

KA 601030

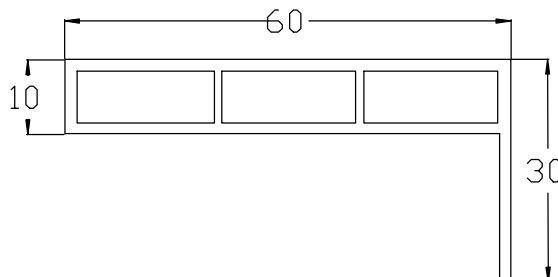

KA 25010

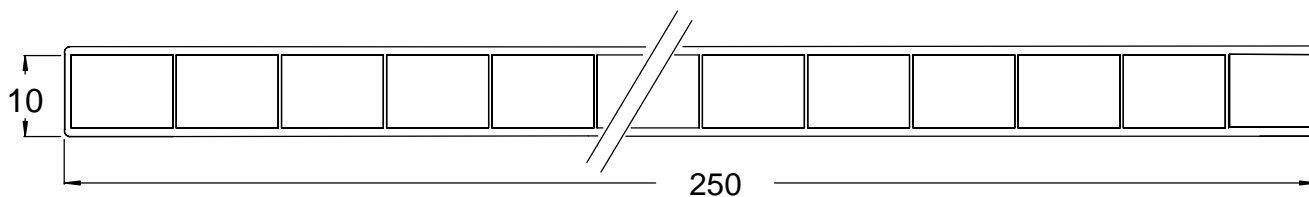

KA 150.11

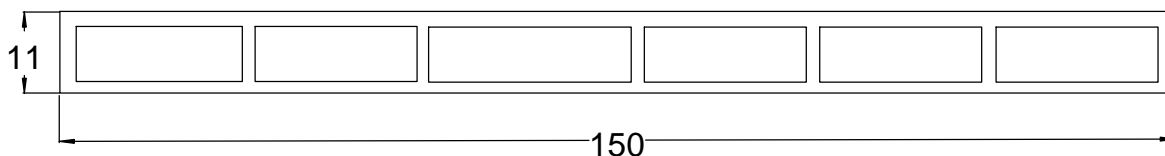

KA 181.11

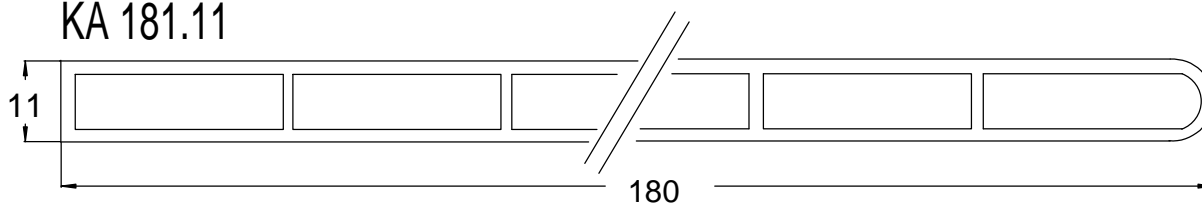

## KAMMERLEISTEN 12, 15 und 20 mm

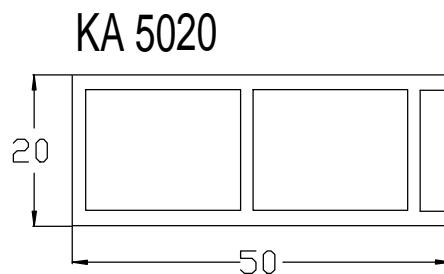
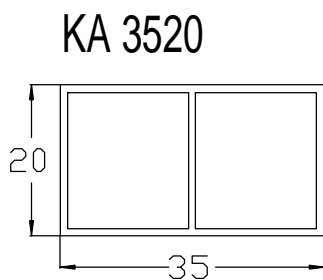
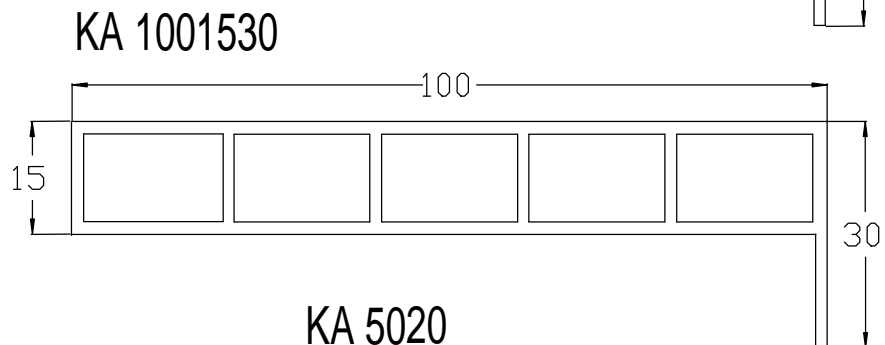
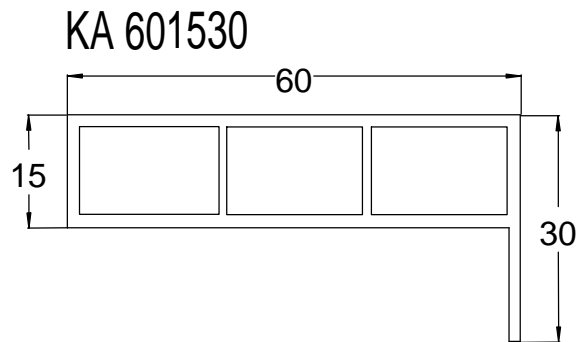
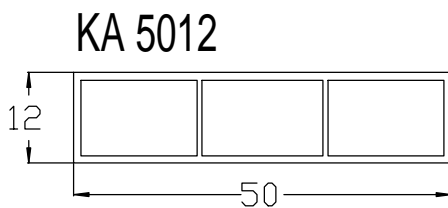
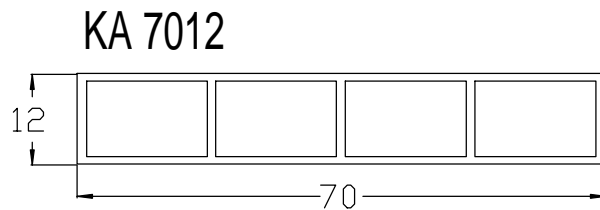
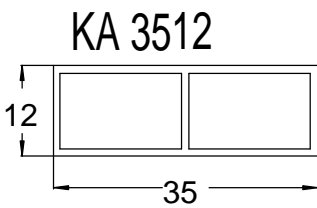
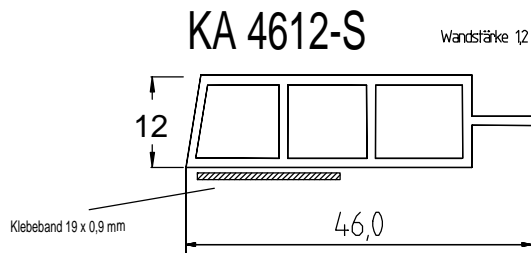
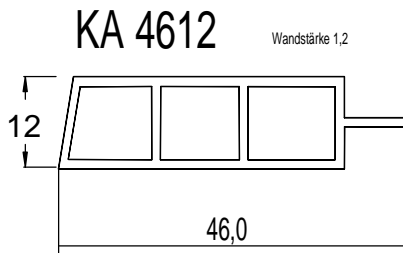

KA 6020

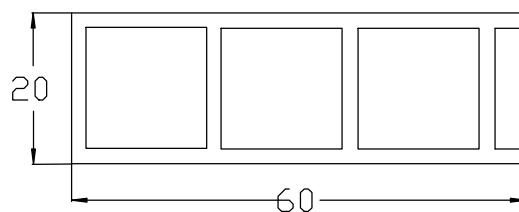



## DECKLEISTE UND KLEMMSCHIENE

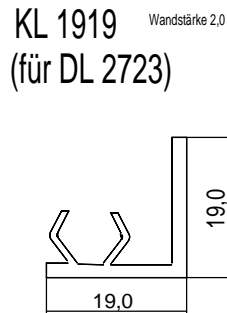
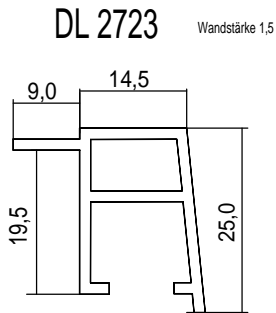

## KAMMERLEISTEN

KA 1322  
 Wandstärke 1,3

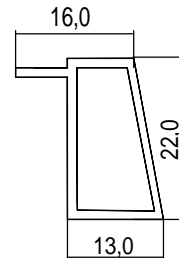

KA 1335  
 Wandstärke 1,3

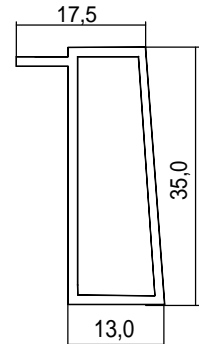

## KLIPSPROFILE UND SCHRAUBEN

KA 2720 Wandstärke 1,5

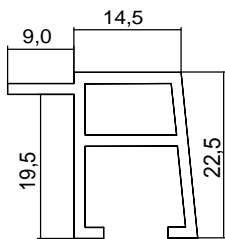

Bohrschraube NI 935  
 (für KA2720 + KA6016)

DL 8015 Wandstärke 1,8

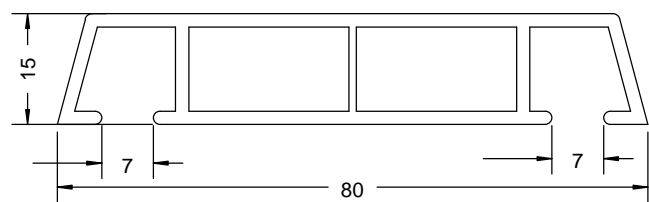

Bohrschraube NI 951  
 (für DL8015)



## WETTERSCHENKEL

WS 1717

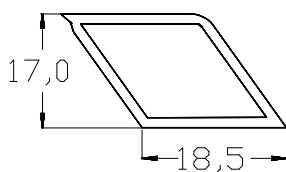

WS 1717-S

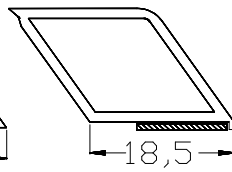

KA 6016 Wandstärke 1,0

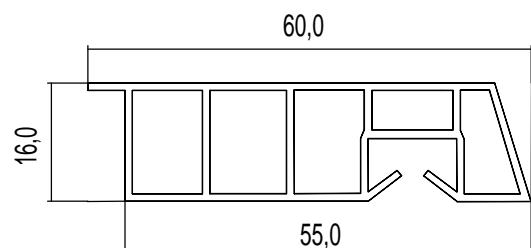

## MEHRZWECKLEISTE

MZ 5010

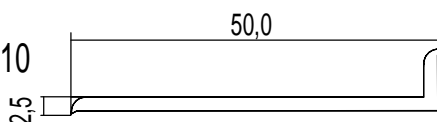

## KAMMERPROFIL

