

GLASSPROSSEN SELBSTKLEBEND

GL 2510-S

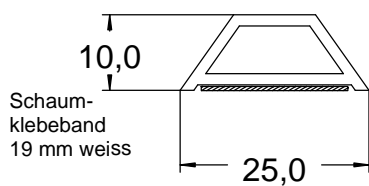

GL 2515-S

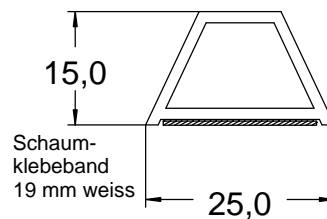

GL 2811-S

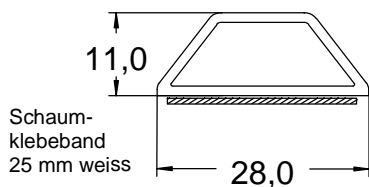

GL 4011-S

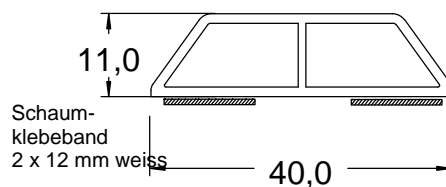

GL 2713-S

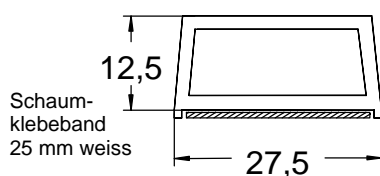

TRSK600

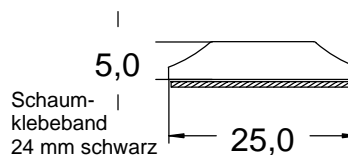

GLASSPROSSEN SELBSTKLEBEND MIT DICHTLIPPEN

Stärke: 8 mm

schwarzes Klebeband, schwarze Dichtlippen

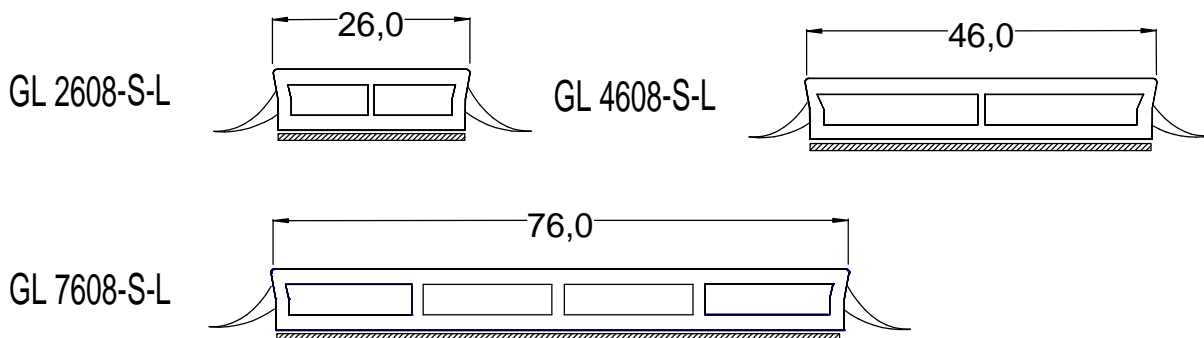

Stärke: 13 mm

schwarzes Klebeband, schwarze Dichtlippen

